

AURORA WORKS

WE ARE READY TO WORK TOGETHER

PRODUCT CATALOG 2021



www.aurora-works.com

Tel: 66 2815 5114 Fax: 66 2815 6128

E-mail: info@aurora-works.com

CONTENTS

Section 1 Company profile	Page.2	Section 9 MAX MÜLLER Sight glass Fittings	Page.10
Section 2 KSPC Tank Protection Devices	Page.3	Section 10 SIMCO Level Solution	Page.11
Section 3 FOSSIL Steam drum Level gauge	Page.4	Section 11 KLOPPER THERM Electric Heating System	Page.12
Section 4 Delta Mobrey Instrumentation	Page.5	Section 12 GSI Tank Gauge Solution	Page.13
Section 5 Barton Firtop Filtration	Page.6	Section 13 Project Reference	Page.14
Section 6 Technical High Pressure Safety Valve	Page.7	Section 14 Service Solution	Page.15
Section 7 EPIC® Sensors Temperature Solution	Page.8	Section 15 Letter of Authorization	Page.16
Section 8 ELMESS Explosion Proof Heater	Page.9	Section 16 Our Customer & Contact Us	Page.17-18

With more than 15 years' experience for engineering team, Aurora Works Co., Ltd. Is a market leader in the following field;

- Supply Tank Protection Devices, Instrumentation and Valve.
- Support a wide range of industrial from manufacturing to process control integrators.

Industrial Applications Include;

- Power plant, Cogeneration plants
- Petrochemical
- Chemical Processing
- Automotive Manufacturing
- Food and Beverage
- Cement Industries
- Oil & Gas; and Product Tank Farm
- Refinery
- Pulp & Paper
- Water and Water Treatment
- Steel and Metal
- Pharmaceuticals



Breather Valve & Breather Valve With Flame Arrester



Pilot Operation



Emergency Vent Cover



Liquid Seal Zero Leak



Flame Arrester



Gauge Hatch Cover



N2 Blanketing Valve



Visual Gauge Glass

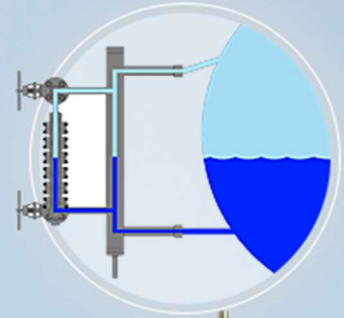

AQUARIAN 3000 Visual Bi-Color

Port Gauge Components



AQUARIAN 650R Reflex Gauge



AQUARIAN 1000T Flat Glass Gauge

Electronic water Level Indicator



AQUARIAN 3000 Mini

Remote Display

Local Control and Display

AQUARIAN Probe



AQUARIAN 1000 PLUS

Remote Display

Valve & Instrumentation



FPS Series



Gas&Oil Ignitor Nozzles



Flame Scanner

Pressure & Differential Pressure



Transmitters



Ex Proof Switch

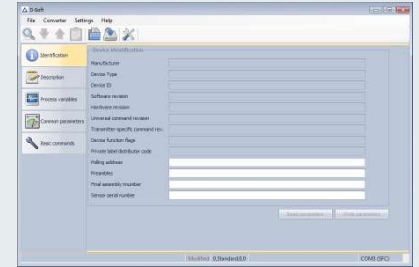

D-Soft Interface

Temperature

Flow



Ex Flow Switch



Ex Temperature Switch

Level

Water & Steam



**Hydra Step / Hydra-Tect
Conductivity Probe**



Ultrasonic



Displacer



Paddle



**Magnetic
Float Switch**



**Boiler
Water Level**



Basket Filter



Bolt Cover Basket Filter

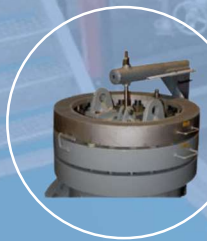

Bolt Cover
Safety Closure

Basket Strainers



Quick Release



Bolt cover

Conical Strainers



Bath Tub Strainer



Conical Strainer

Duplex Strainers



Firplex Strainer



Bi Simple Strainer

Fabricated Strainers



Stainless steel



High Pressure Design



Y-Type Butt Weld



Y-Type Conical

Filter Separators



Horizontal

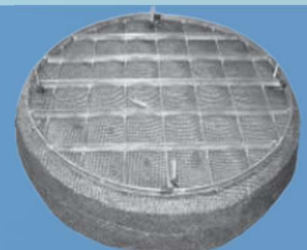

Demister Pad

Safety Valves



30000



30000 P



20000



10000



4000



SV 10001



SV 5001

Safety Valve Specification

SERIES	CONNECTIONS	MAX SET P	MATERIALS	APPLICATIONS
SV 10001	1/4" x 1/4"	700 bar	SS & SP	GAS & LIQUID
SV 5001	1/2" x 1/2"	330 bar	SS & SP	GAS & LIQUID
10000	1/2" x 1" to 2" x 2 1/2"	412 bar	CS, SS, SP	GAS & LIQUID
4000	1/2" x 1/2" to 2" x 2"	412 bar	SS, PL, SP	LIQUID
20000	1/2", 3/4", 1" x 1"	1500 bar	CS, SS, SP	GAS & LIQUID
30000	API 526	412 bar	CS, SS, SP	GAS & LIQUID
30P	API 526	412 bar	CS, SS, SP	GAS & LIQUID

CS Carbon steel; SS Stainless steel; PL Plastic; SP special alloys

Control Devices



Change Over



Control Valve



Pneumatic Pressure Switch



Velocity Check Valve



3 Way Servo Valve



Pneumatic Level Sensor

Temperature Sensors

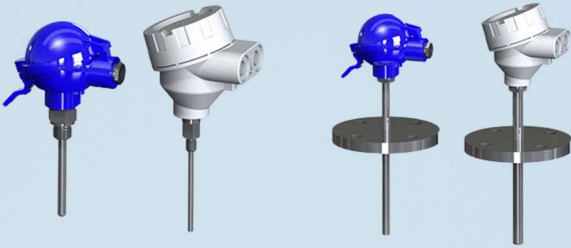

Threaded and Flanged

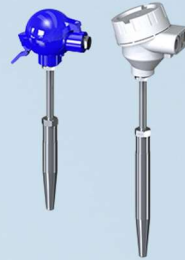

Weldable



Neck Pipe & Sensing Element



Neck Pipe & Thermowell



Thermocouple



Indoor / Outdoor Resistance



Multi Point

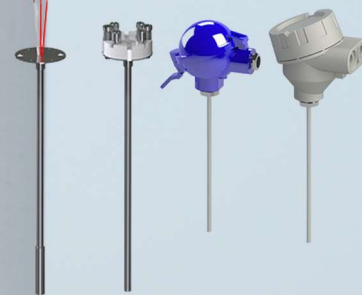

Mineral Insulated



Acid Proof & Hygienic Design

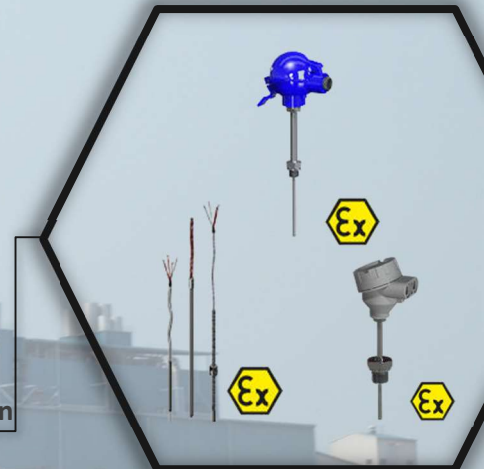

Explosion Proof Design

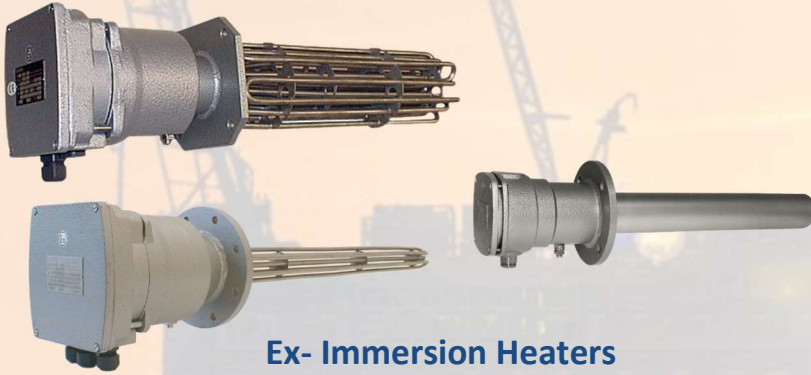

Ex- Immersion Heaters
Fluid, Air, Gas and Compact Body

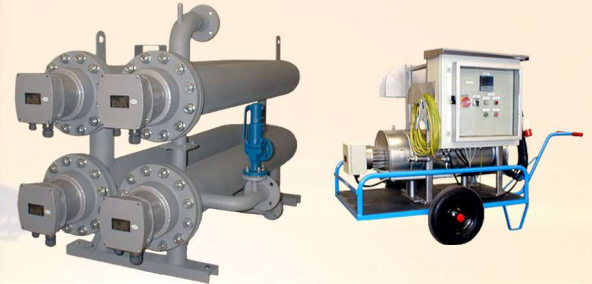

PED, ASME code, other international standards.



Ex- Flow Heaters
Skid & Portable Design



Gas Preheaters & Vaporizers



Onshore and Offshore Control Cabinets



Ex-Cartridge Heaters

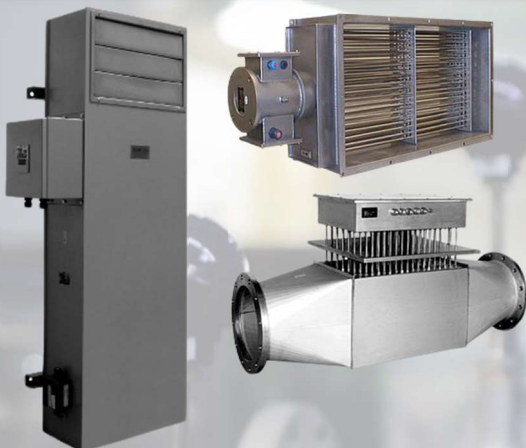

Ex-Air and Blower Heaters



ATEX Thermal Cut-Out

Monitoring Devices



Hazardous Light Fittings



Fibre-optic Lightpipe Light Fittings



Explosion Proof Camera System



Built-in Wiper



Built-in Heating Element



**Sight Glasses
Threaded & Flanged**



Sight Flow Indicators



Light Fitting





Transparent Liquid Level Gauge

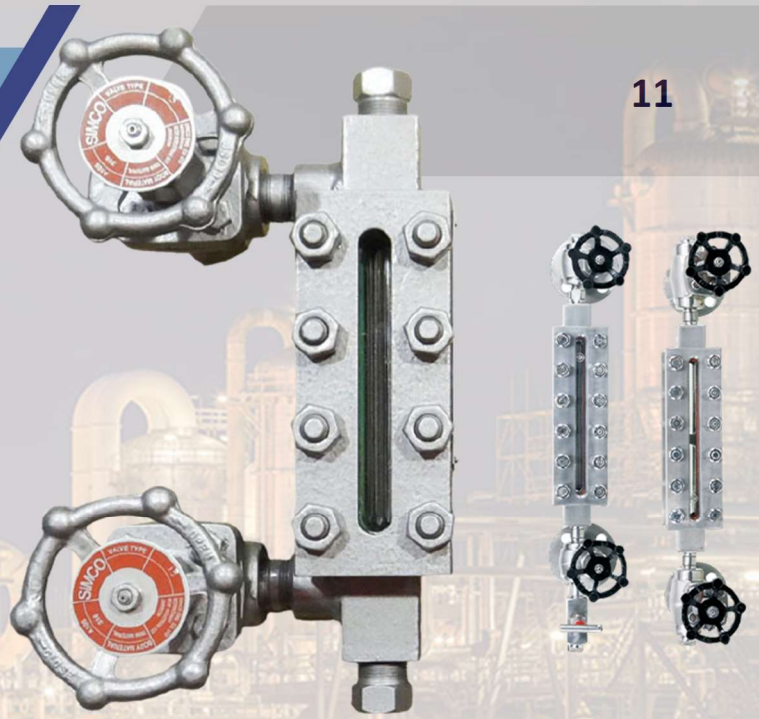

Reflex Liquid Level Gauge

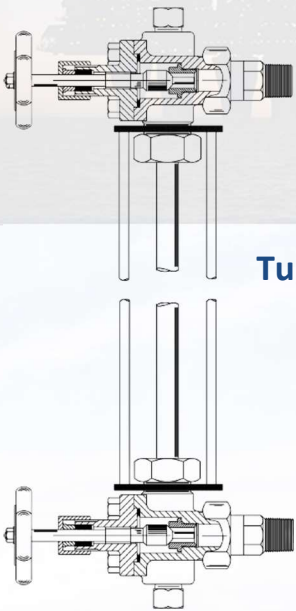

Tubular Liquid Level Gauge



Magnetic Level Gauge



Isolation Valves

Spare Parts



Indicator Rails



Reflex & Transparent Glass



Gaskets



KEL F Glass Shields



Mica Glass Shields

Heater



Hot water Boiler



Steam Superheaters



Power to Heat

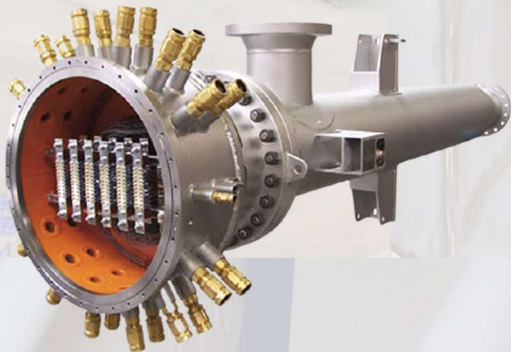

Process Heater



Cable Type Heater



Electric Boiler

Heat Tracing System



Pipe Trace Heating System



Tank Heating System

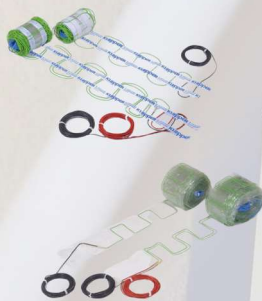

Surface Heating

KLÖPPER THERM
 Elektrische Heizsysteme für industrielle Anwen-
 - Erhitzer- und Sondenheizungen
 - Begleit- und Frostschutzheizungen
 - Flächen- und Frostschutzheizungen
 - Leistungs- und Wärmeschranken
 - Elektrokessel



Monitoring and Control cabinet



Mechanical Tank Gauge & Transmitters

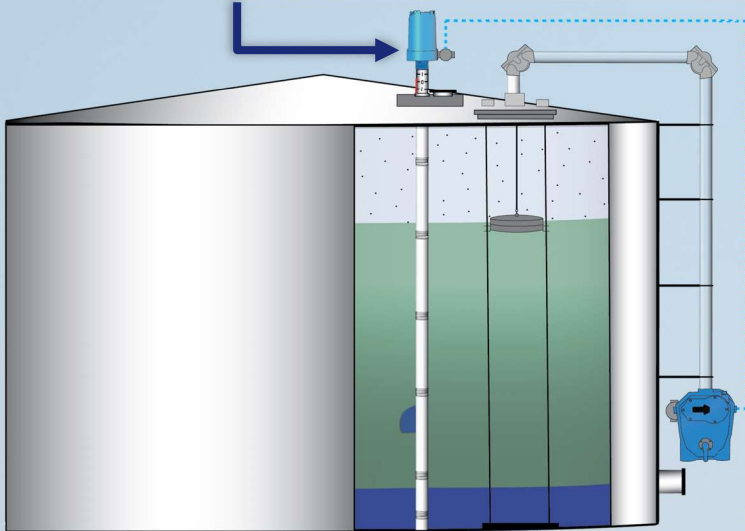

PROJECT REFERENCE

F.Y.	Client Name	Project Name
JAN 2021	IRPC Clean Power Company Limited	Spare part for HP Drum Boiler SN 143-045,046,047,048 / FOSSIL
DEC 2020	Glow SPP 3 Co., Ltd.	PN: 9300-0002 Aquarian High Pressure Conductivity Probe / FOSSIL
DEC 2020	Siam Kraft Industry Co., Ltd. (Ban Pong)	FPS Upgrade Double Mica Rebuild Port Kit / FOSSIL
DEC 2020	Best Tech & Engineering Limited	Deluxe Gauge Kit with a Liquid Seal - GPD Project / GSI
DEC 2020	PTT Exploration and Production PLC	Request Quotation for OLG/M-SP-20201125- Stock replenishment 1100180886 / BARTON FIRTOP
NOV 2020	IRPC Clean Power Company Limited	Spare part for AUX BOILERS; SN 146-051 / FOSSIL
NOV 2020	Glow SPP 3 Co., Ltd.	Thermocouple, Type K, for replacement 2020 / SKS
OCT 2020	Ratchaburi Electricity Generation Co., Ltd	Spare part Aquarian 3000 MINI Block 3-1 LP Drum / FOSSIL
OCT 2020	Glow SPP3 Co., Ltd.	Aquarian 3000Visual Ported Gauge Rebuild Port Kit / FOSSIL
SEP 2020	Thai Petroleum Pipeline Co., Ltd.	SPARE KIT, SWITCH MECHANISM H4 / DELTA MOBREY
SEP 2020	Nakornphet Greenergy Ltd.	FPS Upgrade Double Mica Rebuild Port Kit / FOSSIL
SEP 2020	Thai Rotary Engineering Public Co., Ltd.	PTT LNG Nong Fab LNG Receiving Terminal Project
SEP 2020	Siam Kraft Industry Co., Ltd. (Ban Pong)	FPS Upgrade Double Mica Rebuild Port Kit / FOSSIL
AUG 2020	Veerasuwan Co., Ltd.	REFLEX TYPE LEVEL GAUGE / NEW FLOW
AUG 2020	Thai Ethoxylate Co., Ltd.	Immersion heater for 01V009 / ELMESS
AUG 2020	SYSTANO CO., LTD.	Pressure Difference Switch / DELTA MOBREY
AUG 2020	KI Sugar Group	FPS Upgrade Double Mica Rebuild Port Kit for Boiler 04 / FOSSIL
JULY 2020	PTT Gas Separation Plant	Fuel gas heater Controller พื้นที่ OCS3 จำนวน 3 ตู้ 1120014683 / ELMESS
JULY 2020	Siam Kraft Industry Co., Ltd. (Ban Pong)	FPS Upgrade Double Mica Rebuild Port Kit / FOSSIL
JUNE 2020	PTT Exploration and Production Public Co., Ltd.	1101 PTTEP Bangkok B15, B16, B17 / ELMESS
JUNE 2020	SSUT Co., Ltd. (Power plant Bang-Pu)	Level Switch Project for Steam Pipeline Improvement Project / FOSSIL
JUNE 2020	PPTC Co., Ltd. (Power plant Ladkrabang)	Level Switch Project for Steam Pipeline Improvement Project / FOSSIL
MAY 2020	Thai Ability Engineering Co., Ltd.	DMK Intoplane Substation Project / TECHNICAL
MAY 2020	Ratchaburi Electricity Generating Co., Ltd.	Pressure Difference Switch / DELTA MOBREY
APR 2020	EGAT Nampong Power Plant	FPS Upgrade Double Mica Rebuild Port Kit / FOSSIL
APR 2020	Ratchaburi Electricity Generating Co., Ltd.	Electronic level model AQ3000 Mini spare part new column with probe Block 2-1 HP Drum / FOSSIL

Services

Tank Protection Devices



Ex Electric Heater

- Testing / Calibration Onsite and Rayong workshop
- Installation / Consultancy Design referenced API2000
- Overhaul and Troubleshooting



Installation

Maintenance

Glass Replacement

Level



- Design Heater for Ex Proof
- FAT/SAT Commissioning
- Troubleshooting
- Heater Training
- Installation



OUR CUSTOMER

Petro and chemical Industries



Oil&Gas Industries



Industrial Gas



Tank Farm and Terminals



Power Plant



Pulp and Paper Industry



Engineering



Sugar / Vegetable Oil



Other Business



Biodiesel / Ethanol



Food and beverage



AUTHORIZATION

KSPC

AGENCY AGREEMENT

THIS AGREEMENT IS MADE ON THE DAY OF 01st, JAN. 2017.

BETWEEN
KOREA STEEL POWER CORPORATION, AS MANUFACTURER,
 488-1, WOLSAH-RO, YONGIN-SI, GYANGGI-DO, KOREA
 TEL: 82-31-998-3825-7 FAX: 82-31-998-3828

AND
AURORA WORKS CO., LTD
 88/24 Soi PRACHATHIT 86, PRACHATHIT ROAD, THUNG KHROI, BANGKOK 10110
 TEL: 66 2815-8114 FAX: 66 2815-6128
 (HEREIN AFTER REFERRED TO AS 'AGENT')

1. APPOINTMENT OF AGENT

1.01 COMPANY HEREBY APPOINTS THE AGENT AS ITS EXCLUSIVE REPRESENTATIVE FOR THE SALE OF COMPANY PRODUCTS/SERVICES AND EQUIPMENT. THE AGENT ACCEPTS THE SAID APPOINTMENT AND AGREES TO PROVIDE THE SERVICES SPECIFIED IN THIS AGREEMENT.

1.02 REPRESENTATION OF COMPANY IN THE ASSIGNED AREA WILL BE CONDUCTED BY THE DESIGNATED AGENT, AND ANY DECISION MUST BE APPROVED AND AGREED TO BY COMPANY PRIOR TO WRITTEN COMMENT. SUCH COMMENT MUST BE OBTAINED BEFORE ANY SALES ARE MADE OR COMMISSIONS WILL BE DISTRIBUTED TO AGENT BY COMPANY.

1.03 AGENT IS AN INDEPENDENT CONTRACTOR AND COMPANY SHALL IN NO MANNER BE CONSIDERED HIS EMPLOYER, AND COMPANY SHALL NOT BE LIABLE FOR ANY ACT AS EMPLOYER, INCLUDING BUT NOT LIMITED TO PAYMENT OF ANY TAXES, EXPENSES OR OTHER COSTS OF DOING BUSINESS.

[Signatures and stamps of KSPC and Aurora Works Co., Ltd.]

AGENT: Aurora Works Co., Ltd.

FPS FLUE GAS CONTROL, CORROSION MANAGEMENT & TREATMENT FOR THE STEAM POWER INDUSTRY

ENTIRE AGREEMENT

This Agreement constitutes the entire agreement between the parties and supersedes all previous agreements, understandings or arrangements. No amendment to this Agreement shall be valid unless this Agreement constitutes the entire agreement between the parties and supersedes all previous agreements by the parties hereto.

[Signatures and stamps of FPS and Aurora Works Co., Ltd.]

AGENT: Aurora Works Co., Ltd.

delta-controls

Certificate of Appointment

This is to certify that

Aurora Works Co. Ltd Thailand

has been appointed by

Delta Controls Ltd

as the

Sole Sales Representative

for

Delta Controls products in Thailand

Valid from 1st January 2018 to 31st December 2019

[Signatures and stamps of Delta Controls Ltd and Aurora Works Co., Ltd.]

technical

Date: 17 October 2016

to: **AURORA WORKS CO. LTD**
 1234 Main Street
 1. Building/precinct, A Phrasangphit
 Samyathet 1000
 THAILAND

ATTN: KONGKARN CHUMMANA
 (Sales Director)

Dear Sir,

Subject: PRODUCT REPRESENTATION IN THAILAND

We, TECHNICAL S.A., hereby confirm that our company, AURORA WORKS has been appointed as our EXCLUSIVE AGENT especially in Oil & Gas Market in the territory of THAILAND for our products as follows:

With immediate effect MMS MACHINERY (S) SDN BHD shall represent our company for the below products:

**Fast Shutdown Safety Relief Valve (DSR) 100000
 Compressed Safety Relief Valve (CSR) 100000, 1000000, 4000, 10000, 20000, 30000
 Improved Relief Safety Valve (IRV)
 All other PRODUCTS, part of the TECHNICAL's product range**

This appointment is within the terms of the Sales Agreement entered on 07th November 2016 and is valid up to 31st December 2023 and must be renewed in writing (3) months before expiration.

Thank you

Yours faithfully,
[Signature]
Bernardo CAVALLEY
 Director

Dist: Lough, Dist. 48180, Via Turin, 3, 02099 Corchiano (TR) Italy
 Telephone: +39 - 055231940 fax: +39 - 055231941
 WWW: www.technical.it - E-mail: technical@technical.it - Web: www.technical.it

simco
 Liquid Level Gauges and Valves

Date: 19 August 2013

SIMCO ENGINEERS LTD.
 8/202 INDUSTRIAL ESTATE
 100/1000, 1000000, 1000000000
 DUBLIN 15

To Whom it May Concern

We are pleased to confirm that AURORA WORKS Company Limited located at 1234 Main Street, Phrasangphit, Bangkok 10110 Thailand, has been appointed as our Agent for the **PTI, MCC, Blocker Project** for the supply of the Simco Engineers Limited range of Liquid Level Gauges and Valves.

Yours sincerely,
[Signature]
Peter Thomson
 Sales Director

Agent: Aurora Works Co., Ltd.

FIRTOP

Barton Firtop Engineering Company Limited
 1234 Main Street, Phrasangphit, Bangkok 10110 Thailand
 Telephone: +66 2815 8114
 Email: info@bartonfirtop.com

TO WHOM IT MAY CONCERN

This letter is to confirm that Aurora Works Co. Ltd., 1234 Main Street, Phrasangphit, Bangkok 10110 Thailand, has been appointed as our agent.

BARTON FIRTOP

Range of
 CAST & FABRICATED STRAINERS, FILTERS, FILTER ADAPTORS, COALESCERS, FIBREGLASS PRESSURE VESSELS, SAND-MOUNTED FILTER PACKAGES, DISMANTLER PANS, WEST FLOWMETERS, BLENDER BLENDED TREATMENT PLANS, ARRESTERS AND ASSOCIATED ANCHORAGE PIPELINE EQUIPMENT

For the region of
 Thailand

This agreement is valid from the date below until further notice. It shall apply in all cases in this agreement.

Signed by and on behalf of Barton Firtop Engineering Company Ltd.
 Name: T. Balan
 Position: Senior Applications Engineer

Date: 27th August 2014

BARTON FIRTOP ENGINEERING COMPANY LIMITED
 1234 Main Street, Phrasangphit, Bangkok 10110 Thailand
 Telephone: +66 2815 8114
 Email: info@bartonfirtop.com

Agent: Aurora Works Co., Ltd.

SKSAUTOMATTO

APPENDIX 1 (1)

2.3.2016

DISTRIBUTION CONTRACT – AURORA WORKS CO., LTD

PRODUCTS: Temperature sensors, Detectors under DIFFERENT BRAND

[Signatures and stamps of SKSAUTOMATTO and Aurora Works Co., Ltd.]

AGENT: Aurora Works Co., Ltd.

Klöpper

Die Spezialisten für elektrische Heizsysteme
 The specialists for electric heating systems

to whom it may concern

This is to confirm that the company

Aurora Works Co., Ltd.
 88/24 Soi PRACHATHIT 86, PRACHATHIT ROAD,
 THUNG KHROI, THUNG KHROI, BANGKOK 10110
 THAILAND

The authorization comprises the following Klöpper-Therm product range:

- Electrical Heaters
- Control Panel

This supporting letter will be effective immediately and valid until 31 December 2019. Prolongation will be agreed if both parties are satisfied with their common activities.

Yours sincerely,
[Signature]
Roger Lemmer
 Head of Sales

[Stamp of Klöpper-Therm GmbH & Co. KG]

ELMESS
 THERMOSYSTEMTECHNIK

to whom it may concern

ELMESS-Thermosystemtechnik GmbH & Co. KG
 Heideck 4
 48699 Bielefeld
 Germany
 www.elmess.de

ELMESS-Thermosystemtechnik GmbH & Co. KG is a German based, family-owned company and a leading manufacturer of electrical heating systems for industrial and engineering applications. Based on more than 50 years of experience, we offer design, manufacturing, commissioning, supervision, documentation and training for our customers. We design heaters, fuel heating and surface heating systems in accordance with our customers' expectations and specifications subject to global requirements.

This is to confirm that the company

AURORA WORKS CO. LTD
 88/24 Soi PRACHATHIT 86, PRACHATHIT ROAD,
 THUNG KHROI, THUNG KHROI, BANGKOK 10110
 THAILAND

The authorization comprises the following Elmess-Thermosystemtechnik product range:

- Electrical Heaters
- Control Panel

This supporting letter will be effective immediately and valid until 31 December 2019. Prolongation will be agreed if both parties are satisfied with their common activities.

Yours sincerely,
[Signature]
Reinhard Wagner
 Head of Sales

[Stamp of Elmess-Thermosystemtechnik GmbH & Co. KG]

CONTACT US

ADDRESS Head Office:

888/24 Soi Prachauthit 86, Prachauthit Road,
Thung Khru, Thung Khru, Bangkok 10140
Tel: 66 2815 5114 Fax: 66 2815 6128
E-mail: info@aurora-works.com

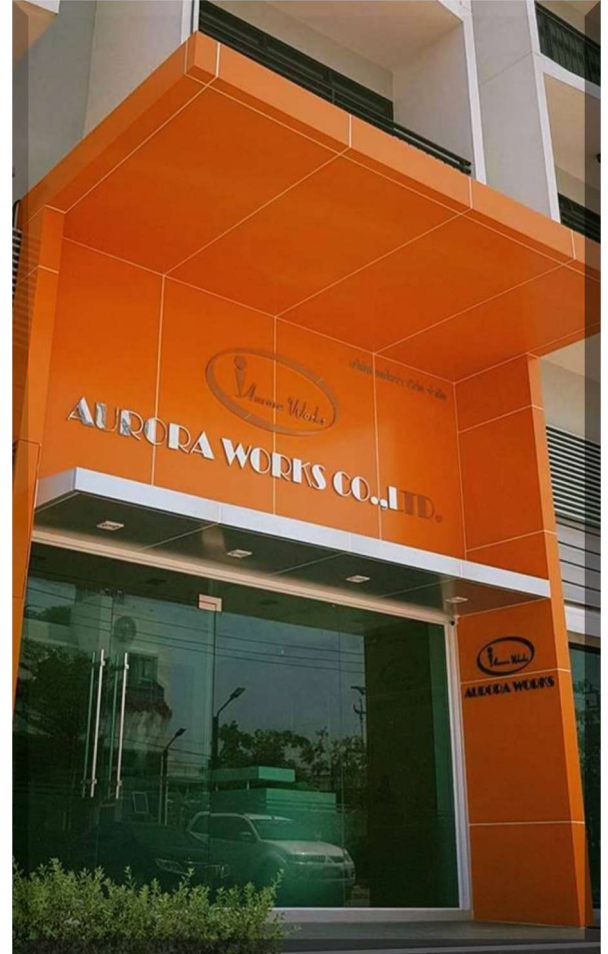

ADDRESS Branch Office:

68/3 National Highway 363 Rd, T.Thapma,
A.Muang-Rayong, Rayong 21000
Tel: 66 38 682 821 / 66 89 499 1139